

Power Supply 5V

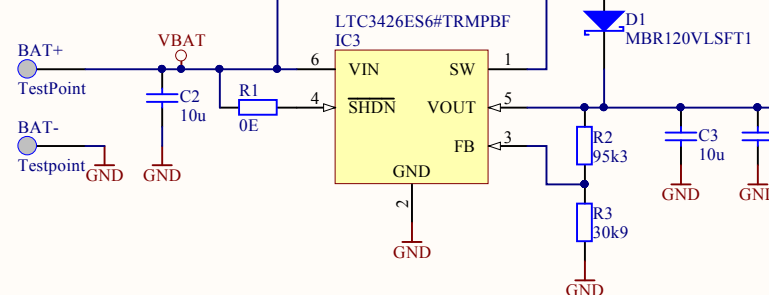

Power Supply +5V

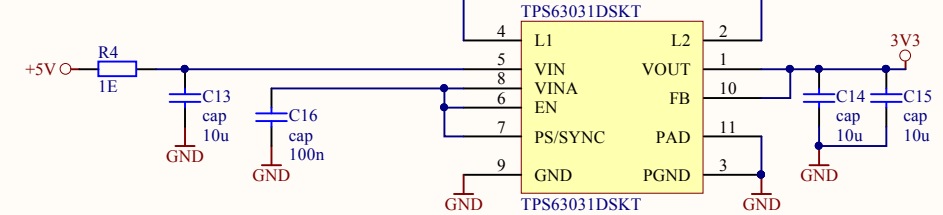

Level shift

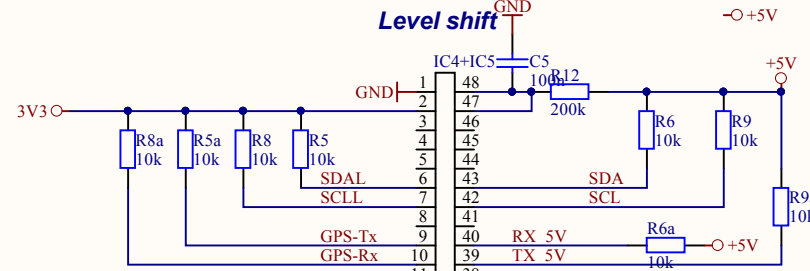

NBFM 144.800MHz Tx

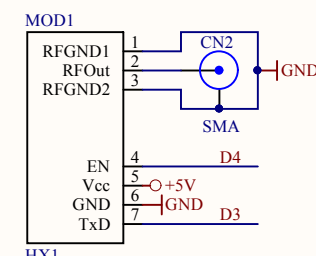

Reset

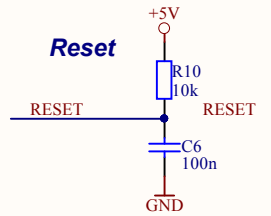

AVbRains

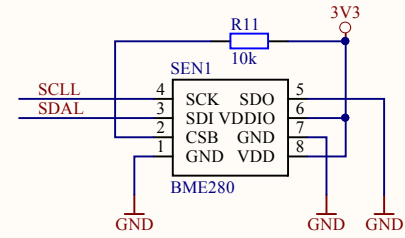
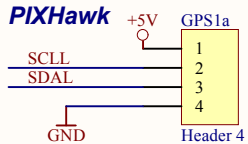
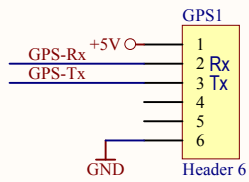
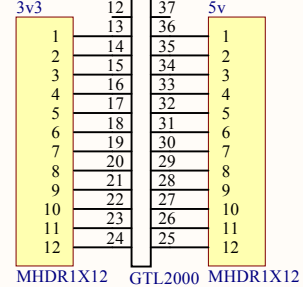
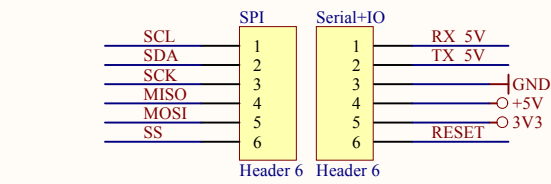
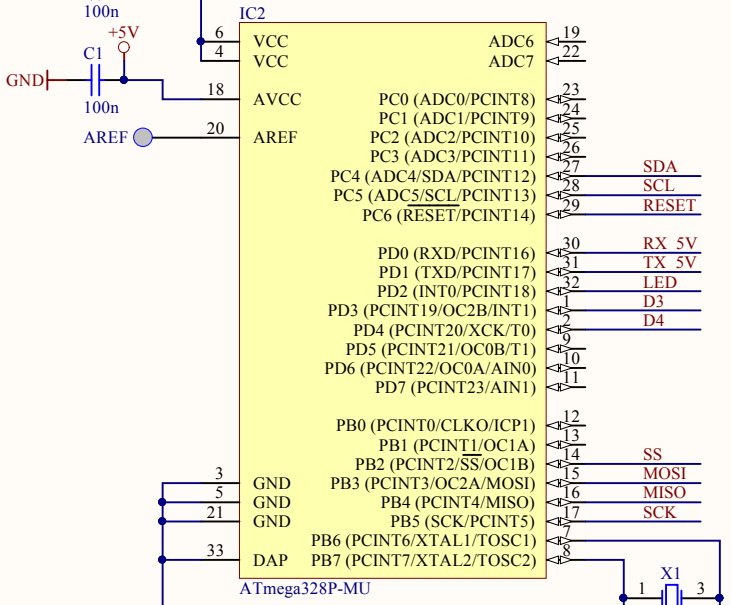

Rh, T, p sensor

Title		
Size	Number	Revision
A4		
Date:	12.2.2018	Sheet of
File:	D:\work\tracker-proto.SchDoc	Drawn By: